

**092**

LARGE OVAL

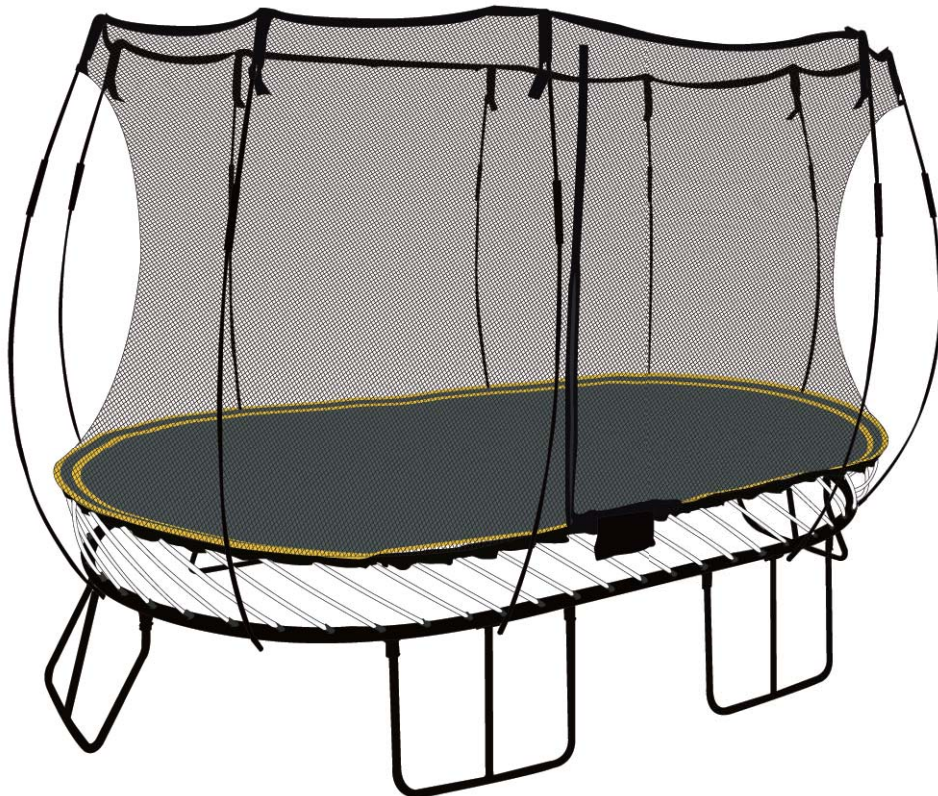

Trampoline & Enclosure  
Assembly Instructions



Safe user weight 250 lbs (115 kg)  
Version 718402

The information in this document is subject to change without notice.  
© Copyright Springfree Trampoline Inc. 2005, 2013. All rights reserved.



**WARNING:** Read the warnings on this page and those contained in the User Guide before you assemble and use the trampoline and enclosure.



Do not attempt or allow somersaults. Landing on the head or neck can cause serious injury, paralysis or death even when landing on the middle of the bed.



Do not allow more than one person at the same time on the trampoline or enclosure. Use by more than one person can result in serious injury.



Treat any loaded rod with caution until you are sure it is properly installed or uninstalled. Keep your face well away from any loaded rod.



Never attempt to remove a black net rod from its net pocket or disengage (unlock) the rod sleeve while the black net rod is under tension.



Do not hold onto, or place fingers between the rods while someone is jumping on the trampoline.



Your Springfree trampoline has been designed for residential backyard use by both children and adults. The Safe User Weight for this trampoline is located on the front panel of this manual and on the front of the trampoline packaging. Jumpers above the Safe User Weight run a higher risk of injury and should not use the trampoline. Jumpers at or near the Safe User Weight should take extra precaution in their manoeuvres to ensure they do not initiate contact with the ground while jumping as this can cause serious injury.



## Assembly Precautions

Read the following steps before beginning the assembly process.

1. Keep small children at least 25 ft (7.62 m) away while assembling the trampoline; they could be injured by improperly assembled rods releasing and ejecting from the frame.
2. Do not attempt to use the trampoline until it is completely assembled.
3. Installation typically takes two hours to complete. Two people are recommended for assembly.
4. Gloves are recommended during the assembly process.
5. Be aware that when loaded, the rods can spring back and may cause injury.
6. Treat any loaded rod with caution until you are sure it is properly installed. In particular, keep your face well clear of the rods during assembly or disassembly. An improperly installed rod could release and cause facial injury or blindness.
7. The sleeves on the rods are intended to provide protection from any fibreglass fibers or splinters. Do not remove the sleeve.

## Icons used in this Manual

We've included several helpful icons throughout the installation process to help make the assembly of your trampoline as easy as possible. We strongly encourage you to follow these icons carefully. Here is what each one means:



**WARNING** - This icon warns of potential danger. Always pay close attention to these icons.



**NOTE** - We use this icon to flag important information that should not be overlooked.



**TIP** - This icon highlights techniques or tricks you can use to simplify the installation process.



**SCAN HERE** - We use this icon to steer you to our website where we have helpful demonstration videos that will guide you through a specific installation step. For your convenience, we'll also include the web address.

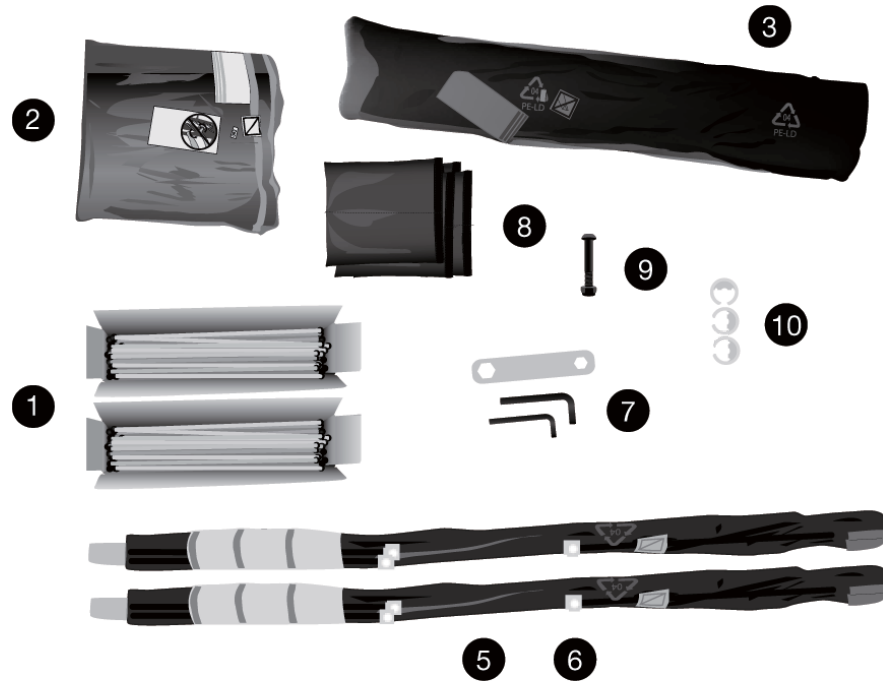

Part	Quantity	Part	Quantity		
1	White Mat Rods	60	6	Black Net Rods	10
2	Mat	1	7	Wrenches	3
3	Net	1	8	Sandbag	4
4	C-clips (attached to frame)	10	9	Spare Small Bolt & Nut	1
5	Horizontal Net Rods	2	10	Spare C-clips	3



**TIP** - Assemble the trampoline on a flat surface.

- Layout all parts listed as shown.



**SCAN HERE** or visit <http://springfr.ee/install-ov> for a helpful installation demonstration video.

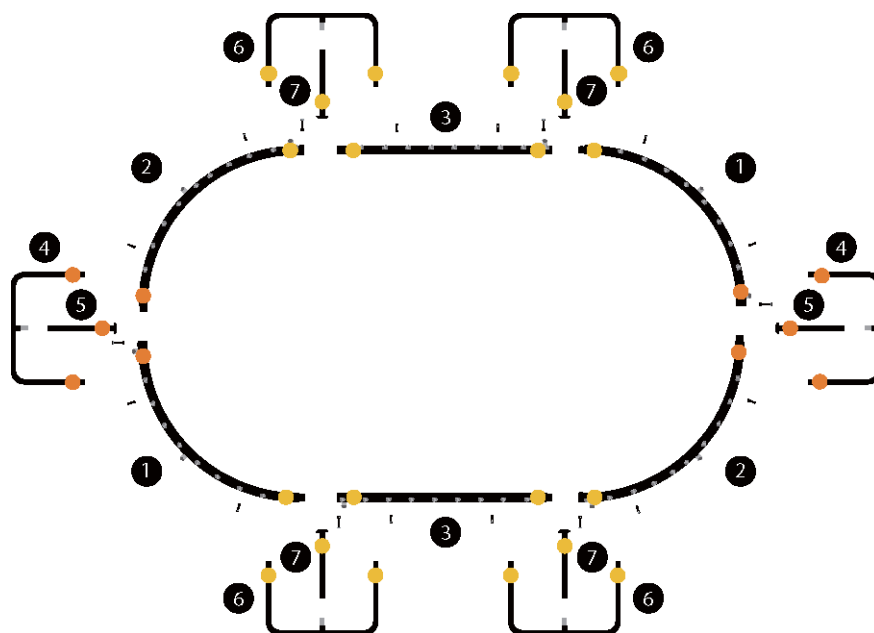

Part	Quantity	Part	Quantity		
1	10-Hole Curved Frame Sections	2	6	Yellow Legs	4
2	11-Hole Curved Frame Sections	2	7	Yellow Center Posts	4
3	Straight Frame Sections	2	8	Small Bolts & Nuts	12
4	Orange Legs	2	9	Large Bolts & Nuts	6
5	Orange Center Posts	2			

- Lay out the remaining frame parts as shown. The orange ● and yellow ● stickers on the frame sections and leg pieces all face upwards.
- If you are missing any parts please contact Springfree® Trampoline directly.



SCAN HERE or visit <http://springfr.ee/step-2> for a helpful installation demonstration video.

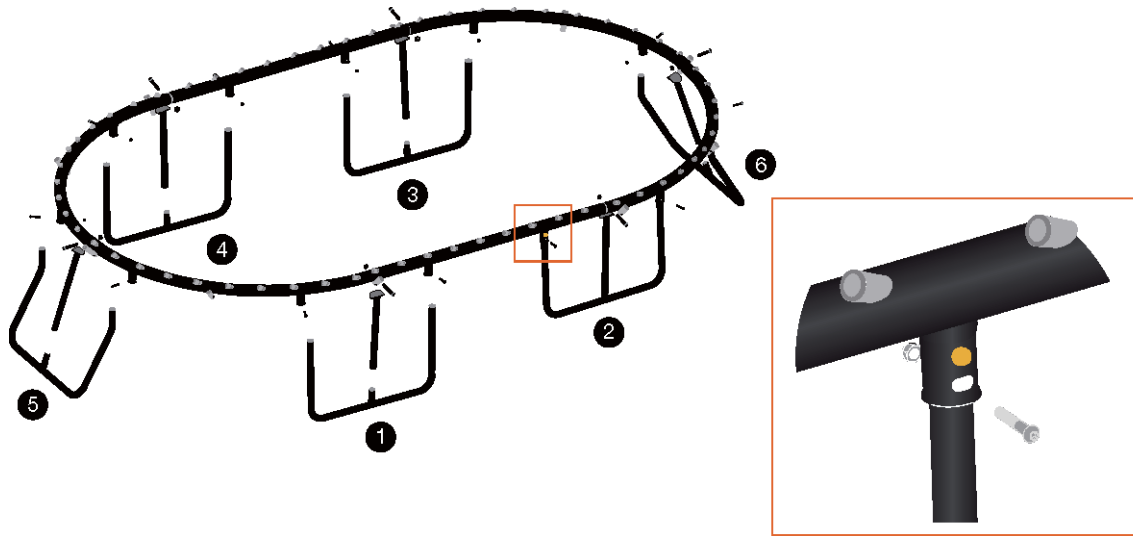

**WARNING** - Use the tools provided. Do not tighten the nuts with a power driver, torque wrench, or drill.



**TIP** - The frame may appear loose after it is assembled but will become tight and rigid once the mat is installed.

- Fasten the frame sections together with the large bolts and nuts.
- Attach a center post to the middle of each leg section. Check that the color on the center post is the same as the leg.
- Then, in the order shown in the illustration, from 1 to 6, lift the frame and evenly put the legs into the leg hole on the frame. We recommend that two people work together to complete this step. One person to hold the frame up and horizontal, and the other person to put the legs into the leg hole.
- Fasten each leg to the frame before going to the next leg.

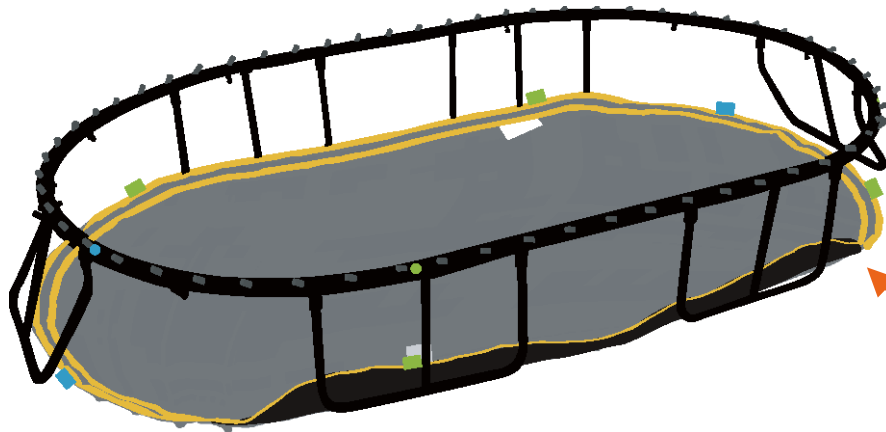

- Lay out the mat with the yellow stripes facing upwards inside the trampoline frame.
- Make sure the blue ■ and green ■ tags on the mat line up with the blue ● and green ● stickers on the frame.
- Before moving to the next step, ensure that the mat rod holders are correctly positioned with the mat rod holder tag outside the mat rod holder pocket, as per the insert. If the mat rod holder tag is under the pocket, adjust accordingly.

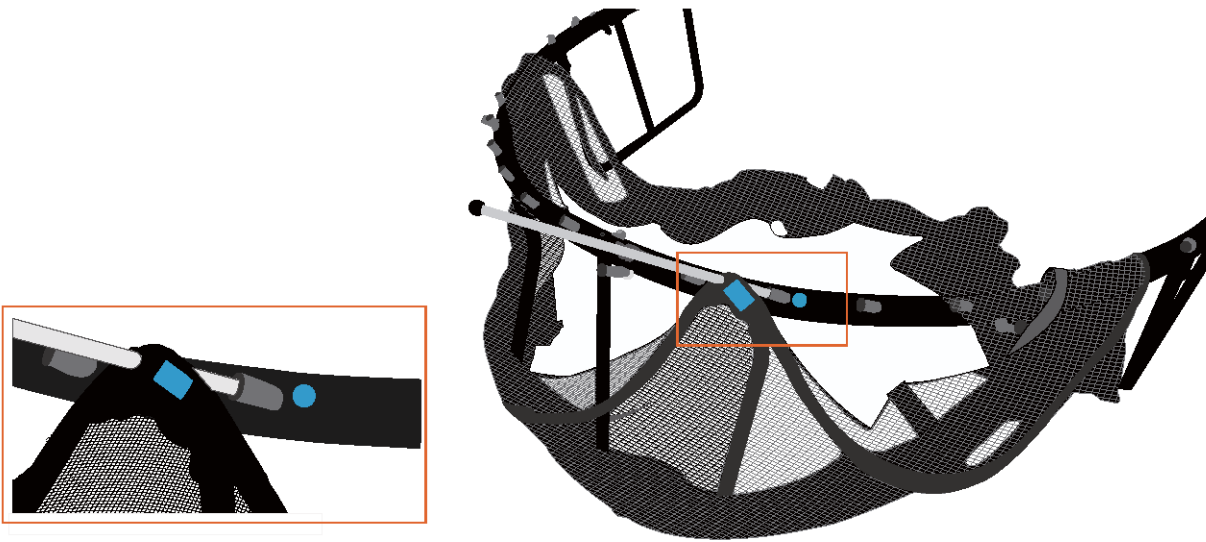
**STOP**

**NOTE** - As you install the white mat rods into the mat rod sockets the net will become tight against the frame. Handle the net with care and be sure that it does not get caught or it may tear.

- Find the hole in the net marked with a blue ■ tag and the mat rod socket on the frame marked with a blue ● sticker.
- Holding the net hole with the blue ■ tag, place the rest of the net inside the frame as shown.
- Orient the net so that the blue ■ tag is facing you and is on the right hand side of the net hole as shown.
- Put a white mat rod through the net hole and into the mat rod socket marked with the blue ■ sticker.
- Working around the frame, insert the remaining white mat rods through the net holes and into the corresponding mat rod socket.
- Be sure that the white mat rods are seated down to the bottom of each mat rod socket.



**SCAN HERE** or visit <http://springfr.ee/step-5> for a helpful installation demonstration video.



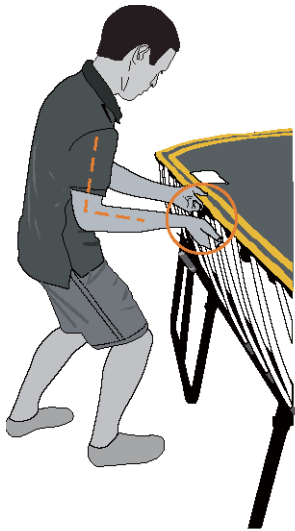

1 Hold the white mat rod with your palm facing up. Stand with one leg forward, bend your knees and hold the mat next to a mat rod holder firmly.



2 Bend your arm at a right-angle, push your elbow into your hip and hold the white mat rod.



3 Push forward rocking from your heels to the balls of your feet, using the weight of your body to push the white mat rod into the mat rod holder while you keep the mat edge horizontal with your other hand

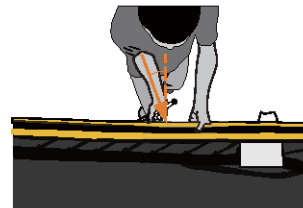

4 Pushing across your body in the direction shown will make it easier to get the mat rods in or out of the mat rod holders.



**WARNING** - Treat any loaded rod with caution until you are sure it is properly installed or uninstalled. Keep your face well away from any loaded rod.

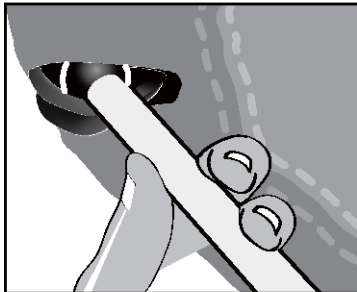
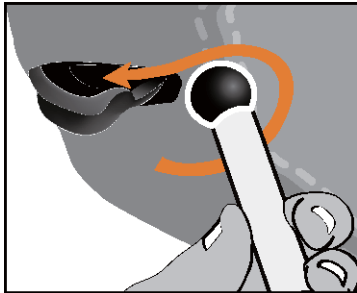
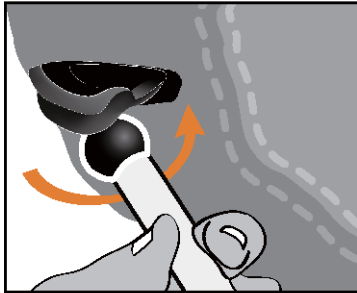

**TIP** - Keep the mat level when you attach the white mat rods.

**TIP** - If you are having difficulty installing the white mat rods, try having a second person push on the opposite side of the trampoline.

---

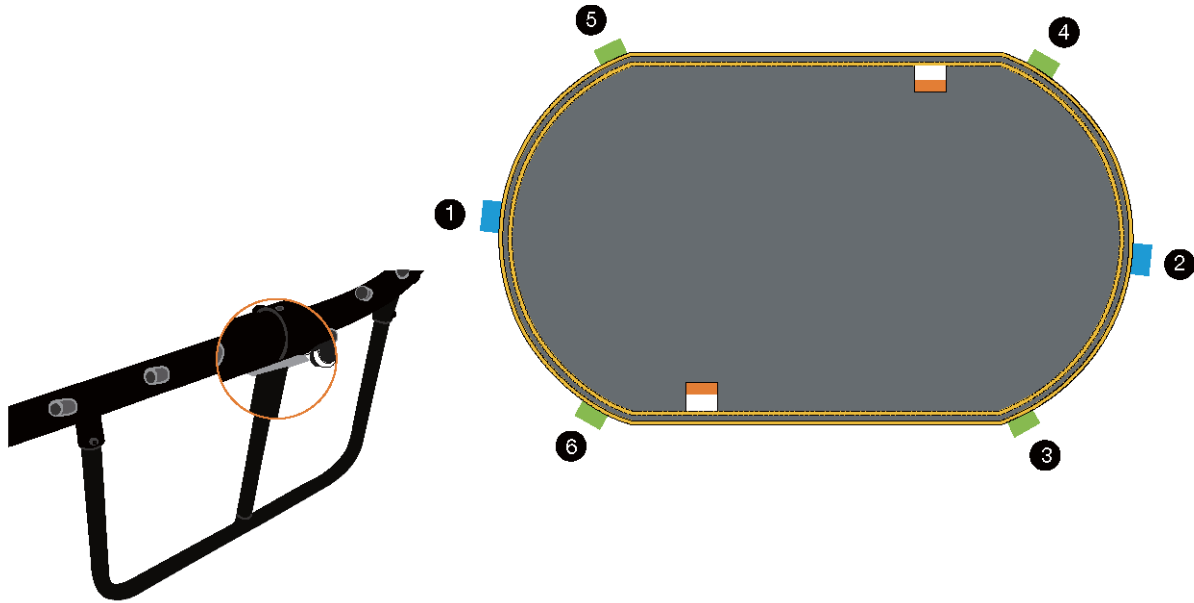

**NOTE** - Check that the center posts of the leg sections are correctly seated against the trampoline frame. If they are not, adjust them now.

- 
- Attach the first six white mat rods to the mat in the order shown. Make sure you correctly match the colored stickers next to the white mat rods with the colored tags on the mat.
  - If you need to take a white mat rod out of the mat see Disassembly Step 2 for instructions.



SCAN HERE or visit <http://springfr.ee/step-6> for a helpful installation demonstration video.

---

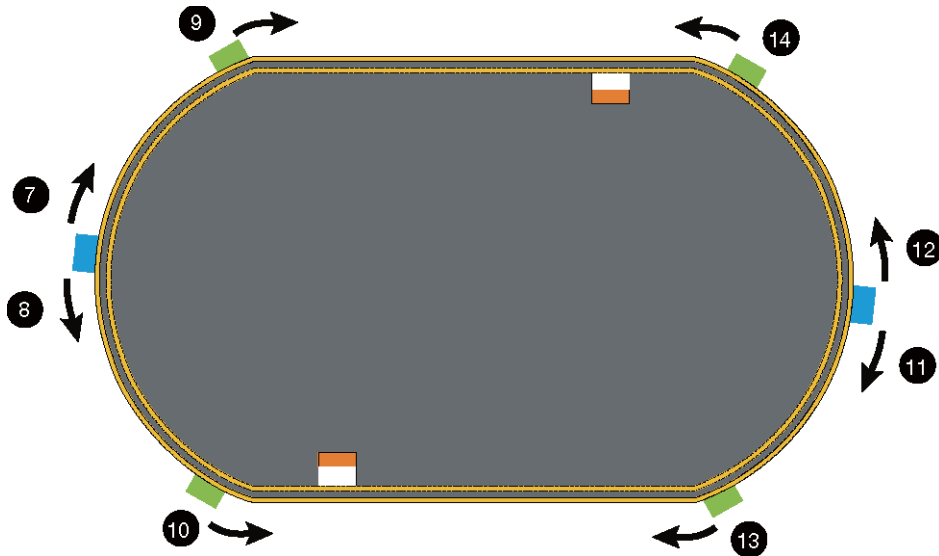

**WARNING** - Treat any loaded rod with caution until you are sure it is properly installed or uninstalled. Keep your face well away from any loaded rod.



**NOTE** - When you have put the ball end of a white mat rod into a mat rod holder, swivel the mat to ensure the white mat rod is correctly seated.

- Attach the white mat rods to the left and to the right of the six initial starting rods, as shown above with the blue and green squares.
- Then, as shown by the above numbers, continue this sequence, one to the left and one to the right, until all of the white mat rods are attached to the mat.

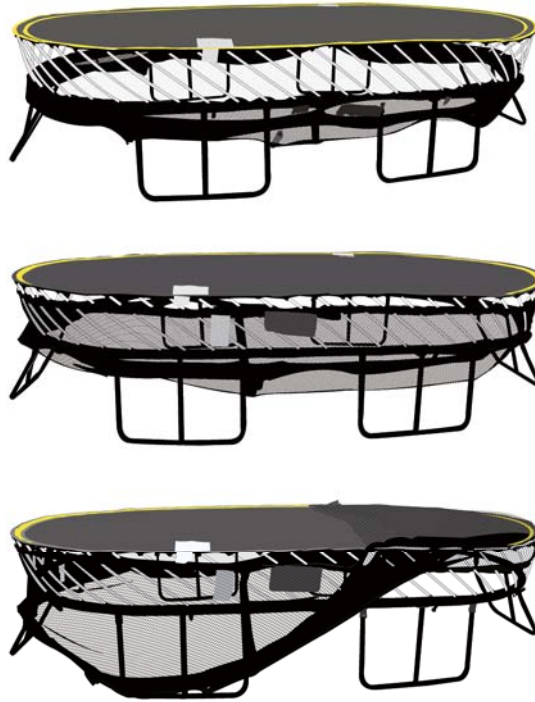

**WARNING** - Do not use the trampoline until it is completely assembled. Failure to follow these instructions may cause rods to break or eject from the trampoline frame.



**NOTE** - Check that the net is not caught on the trampoline frame or the bolts – if the net catches, it may tear.

- 
- Move around the frame from right to left and carefully slide the net up to the top of the white mat rods.
  - Starting at a corner, carefully pull the net up over the edge of the mat.
  - Working around the frame, lift the rest of the net into the center of the mat.

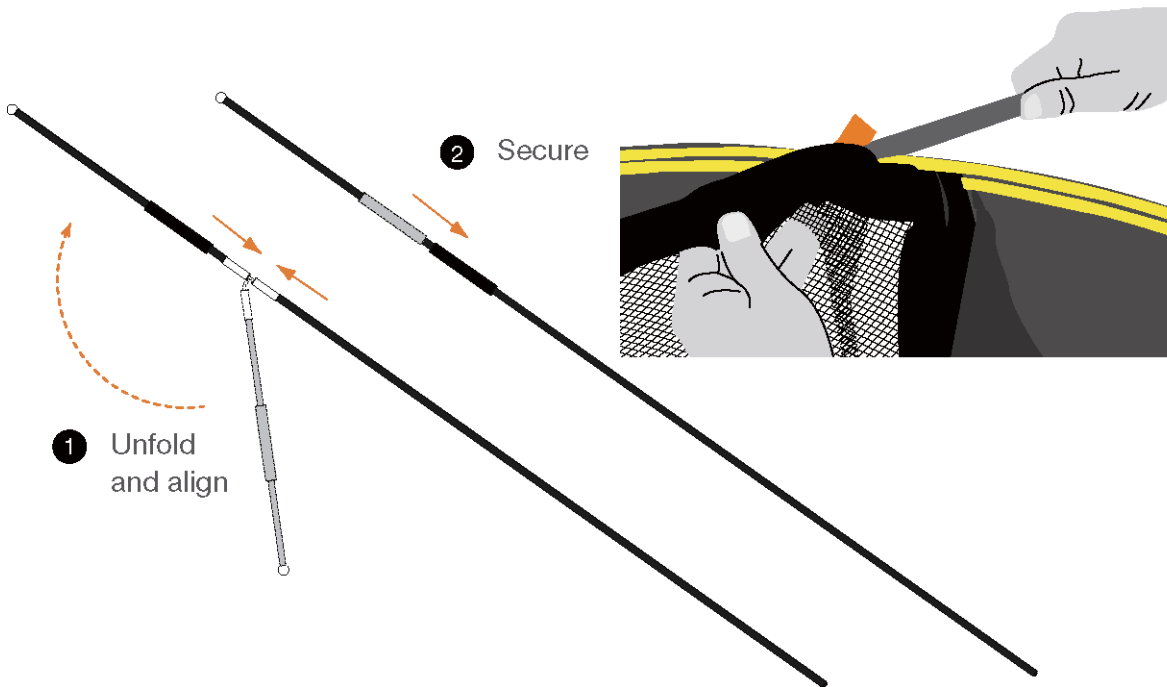

**WARNING** - Treat any loaded rod with caution until you are sure it is properly installed or uninstalled. Keep your face well away from any loaded rod.

- Locate the orange ■ tag along the top edge of the net.
- Slide a horizontal net rod into the pocket at the orange ■ tag. Tuck the end of the rod into the pocket. Once it is fully inserted, check that the rod is centered within the pocket.
- Repeat on the other side of the trampoline.
- Assemble the black net rods as shown.

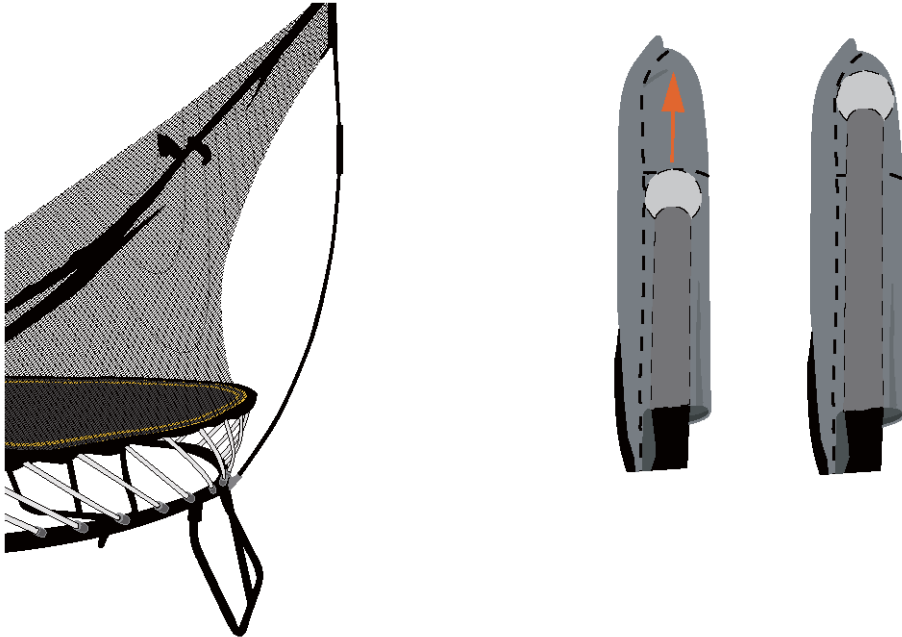

**WARNING** - Never attempt to remove a black net rod from its net rod pocket or disengage (unlock) the rod sleeve while the black net rod is under tension.

- Insert all of the black net rods into the net rod pockets at the top edge of the net. Push the rod up into the pocket and past the catch. You will feel some resistance as the ball is pushed through.
- Insert the bottom end of the black net rod into the net rod socket on the trampoline frame. You will hear a click when the black net rod is fully seated.



SCAN HERE or visit <http://springfr.ee/step-10> for a helpful installation demonstration video.

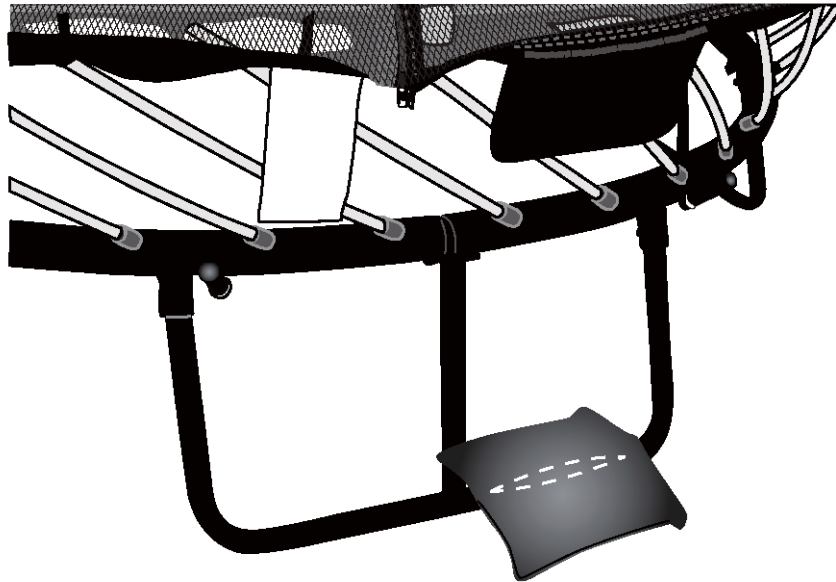

**WARNING** - Make sure you read all warnings and precautions found in the User Guide before using the trampoline.

**WARNING** - If you anticipate severe weather, the trampoline should be moved to a sheltered location or disassembled.

- For increased stability, your trampoline comes with four sandbags.
- Fill these sandbags to approximately 6 inches (150 mm) below the top with wet or dry sand.
- Fold over the top of the bag twice so the Velcro® strips meet. Velcro is a registered trademark of Velcro Industries B.V.
- Place the sandbags over the trampoline legs as required so that the sandbag cannot slip off. We recommend that the stitched seam in the center should lay over the leg tube.
- If your trampoline is installed in an area susceptible to high winds or if you are looking for increased stability for your trampoline, we recommend the Springfree Ground Anchor, which has been designed specifically for the Springfree Trampoline. Ground Anchors can be purchased online at [www.springfree.com](http://www.springfree.com).

Congratulations! You have successfully installed your Springfree Trampoline! Happy bouncing!